

DECORATIEF BESLAG QUINCAILLERIE DECORATIVE



Aluminium
Gemoffeld / Laque



Aluminium
Naturel



Nylon



RVS / Inox



Messing gepolijst
Laiton poli



Messing gebronsd
Laiton bronzé

PROFEL
Europalaan 17
3900 Overpelt (B)
Tel. : 011-809.809
Fax. : 011-809.808
www.profel.be

PROFEL Nederland
Kerver 2 Postbus 49
5520 AA Eersel (NL)
Tel. : 0497-531033
Fax.: 0497-531039
www.profel.nl

PROFELCO France
Zac de la Sente du Moulin
60530 Ercuis (F)
Tél.: 03 44 74 38 80
Fax: 03 44 74 38 90
www.profel.com

profel

Alle rechten voorbehouden. Niets uit deze uitgave mag worden veeelvoudigd, opgeslagen in een geautomatiseerd gegevensbestand of openbaar worden gemaakt in enige vorm of op enige wijze, hetzij elektronisch, mechanisch, door fotokopieën, opnamen of enige andere manier, zonder voorafgaande schriftelijke toestemming van PROFEL.
Correspondentie inzake overnemen of reproductie kunt u richten aan: PROFEL Nv, Europalaan 17, 3900 Overpelt

Ondanks alle aan de samenstelling van dit boekje bestede zorg, kan PROFEL géén aansprakelijkheid aanvaarden voor eventuele schade die zou kunnen voortvloeien uit enige fout, die in deze uitgave zou kunnen voorkomen.
Wijzigingen mogelijk!

Tous droits réservés. Ce document ne peut être reproduit, transmis, retranscrit, conservé dans un système d'archivage documentaire, même partiellement, et ce sous quelque forme et par quelque moyen que ce soit, sans l'autorisation écrite préalable de PROFEL.
Pour toute correspondance relative à une utilisation ou reproduction du texte, veuillez vous adresser à :
PROFEL NV, Europalaan 17, 3900 Overpelt

Malgré tous les soins apportés à l'exactitude des informations contenues dans ce livret, PROFEL décline toute responsabilité en cas d'erreur ou d'omission.
Modifications possibles!

© Copyright 2003 PROFEL, Overpelt.

LEGENDE: LEGENDA:

1 Toepassing binnenzijde
Interieur

1 Toepassing buitenzijde
Exterieur

Met europrofiel cilindergat
Avec trou cylindre

PKM Geschikt voor inbraakwerend klasse 2 volgens Europese voornorm
Approprié pour anti-effraction classe 2 selon prénorme Européenne

Combinatie van twee verschillende nrs. ONMOGELIJK!
Combinaison de deux nr° différents IMPOSSIBLE!

Roepnaam Appellation	Artikel Article	Geschikt voor / approprié pour:													
		Binnenzijde Intérieur	Buitenzijde Extérieur	Met cilinder Avec trou cylindre	PKM PKM uitvoering Execution PKM	PVC systeem Système PVC	ALU systeem Système ALU	HOUT systeem Système HOUT	Raam Fenêtre	Deur Porte	Schuifdeur Couissant trad.	Balkondeur Porte-balcon	Schuif-kip Couissant-tombant		
Leone	Bb-320		•			•	•	•		•					
Mano	Bb-800		•			•	•	•		•					
Maya	Bb-130		•			•	•	•		•					
Missina	Bb-300		•			•	•	•		•					
Monaco	Bb-120		•			•	•	•		•					
Naxos	Bb-420		•			•	•	•		•					
Nu	Bb9200	•	•	•		•	•	•		•					
Psi	Bb9300	•	•	•		•	•	•		•					
Riccio	Bb-310		•			•	•	•		•					
Start	Bb5045	•		•		•	•	•		•					
Start	Bb5645		•	•		•	•	•		•					
Taormina	Bb-210		•			•	•	•		•					
Thema	Bb5044	•		•		•	•	•		•					
Thema	Bb5644		•	•		•	•	•		•					
Thema	Bb9444	•				•	•	•	•						
Vega	Bb5019	•		•		•	•	•		•					
Vega	Bb5619		•	•		•	•	•		•					
Vega	Bb9419	•				•	•	•	•						
Victoria	Bb-100		•			•	•	•		•					
Xenia	Bb5020	•		•		•	•	•		•					
Xenia	Bb5620		•	•		•	•	•		•					
Xenia	Bb9420	•				•	•	•	•						

ALU REEKS GEMOFFELD SERIE ALU LAQUE



LAMBDA



RHO



TAU



ZETA



DELTA 225



OMEGA 225



PI



EPSILON



DELTA 300



SIGMA 300



IOTA



ANTILIA



NU



BILORA



LAMBDA



LAMBDA



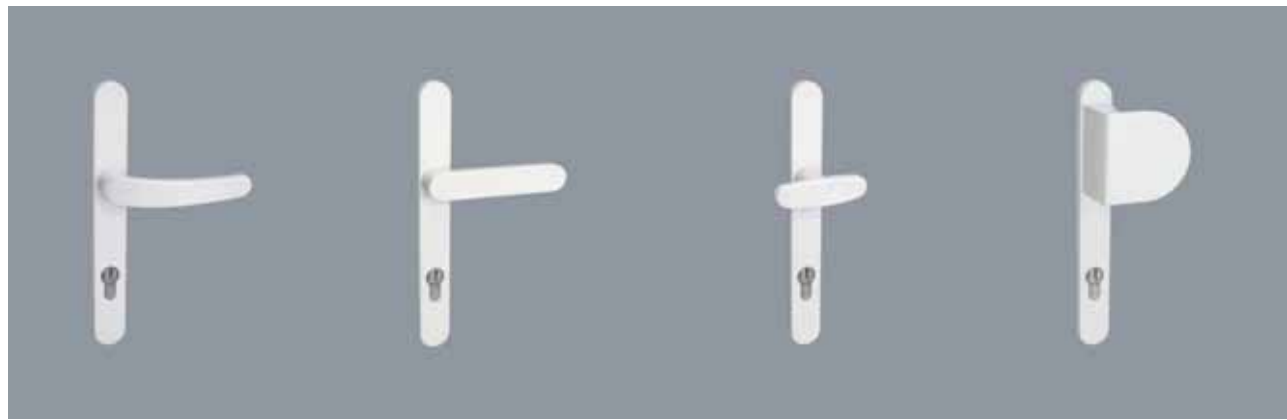

LAMBDA		RHO		TAU		ZETA	
Bs5062	1	Bs5064	1	Bs5080	1	Bs5277	1
Bs5362	1	Bs5364	1	Bs5380	1	Bs5577	1
Be5062	2	Be5064	2	Be5080	2	Be5277	2
Bs5662	1	Bs5664	1	Bs5680	1	Bs5877	1
Bs5962	1	Bs5964	1	Bs5980	1	Bs6177	1
Be5662	2	Be5664	2	Be5680	2	Be5877	2

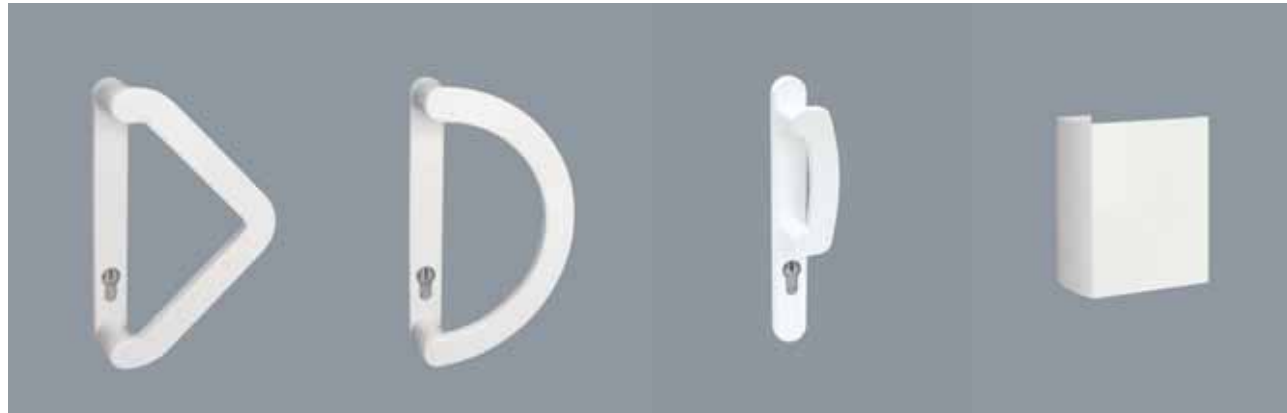

DELTA 225		OMEGA 225		PI		IOTA	
Bs5168	1	Bs5166	1	Bs8075	1	Be0024	
Bs5468	1	Bs5466	1	Bs8275	1		
				Be8075	2	PKM	
Bs5769	1	Bs5767	1	Bs8175	1		
Bs6069	1	Bs6067	1	Bs8375	1	PKM	
				Be8175	2	PKM	



SIGMA 300		DELTA 300		LAMBDA		LAMBDA	
Be2588	2	Be2589	2	Bs9435		Bs9536	PKM
Be2788	2	Be2789	2	Bs9435*	(*=afneembare kruk) (*=poignée démontable)		
Be2688	2	Be2689	2				
Be2888	2	Be2889	2				

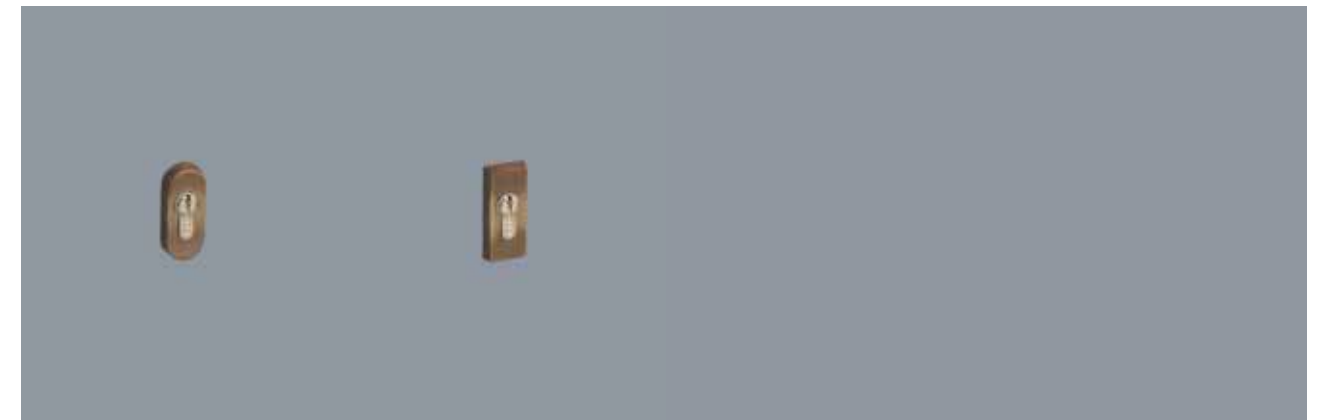

NU	PSI
Bb9200	Bb9300



TAORMINA
Bb-210



VEGA	THEMA	XENIA
Bb9419	Bb9444	Bb9420

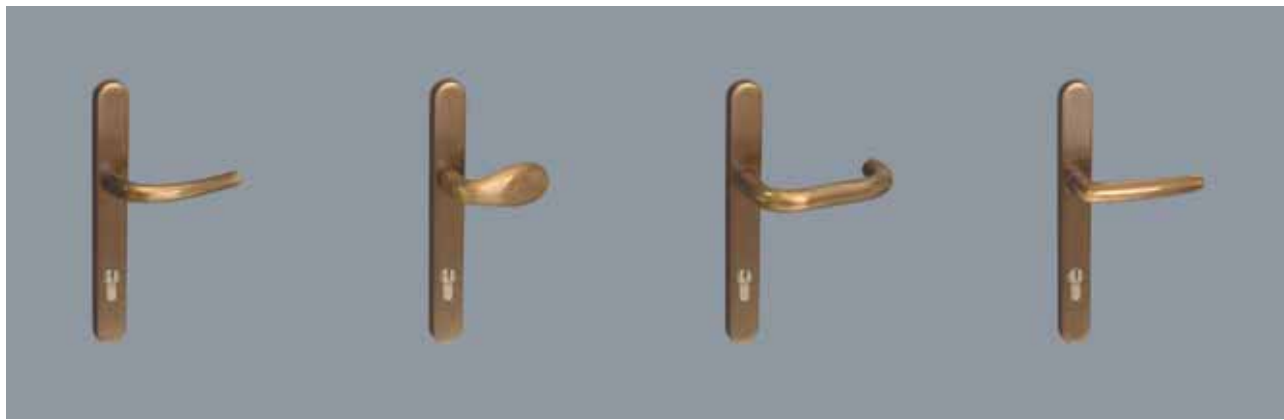

VEGA Bb5019 1	THEMA Bb5044 1	START Bb5045 1	XENIA Bb5020 1
Bb5619 1	Bb5644 1	Bb5645 1	Bb5620 1

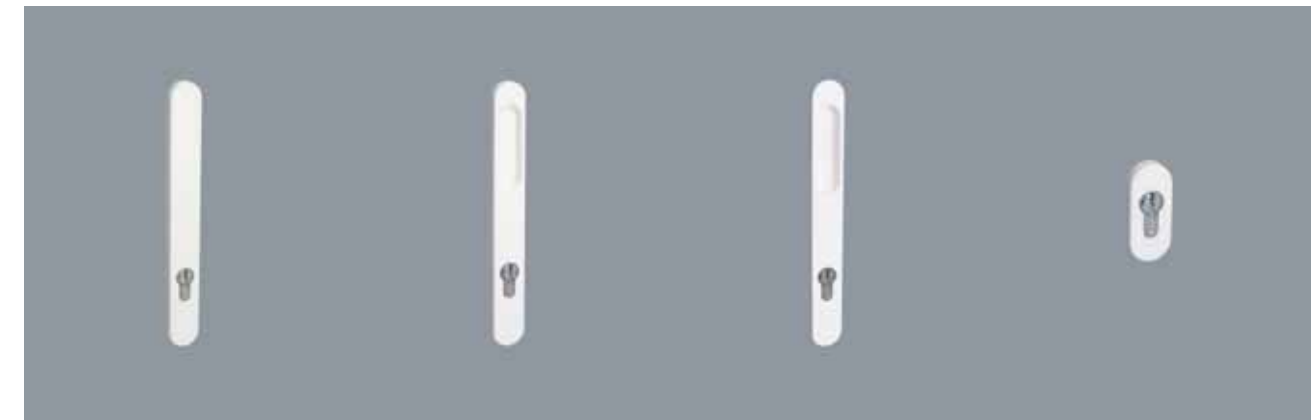

OMIKRON Bs7100 1	EPSILON Be1100 2 PKM	EPSILON	NU
Bs7300 1	Be1300 2		
Be7100 2 PKM			
Bs7200 1	Be1200 2 PKM	Be3200 1	Be9200
Bs7400 1 PKM	Be1400 2 PKM	Be3300 1	
Be7200 2 PKM		(inbouw/M5) (encastré/M5)	

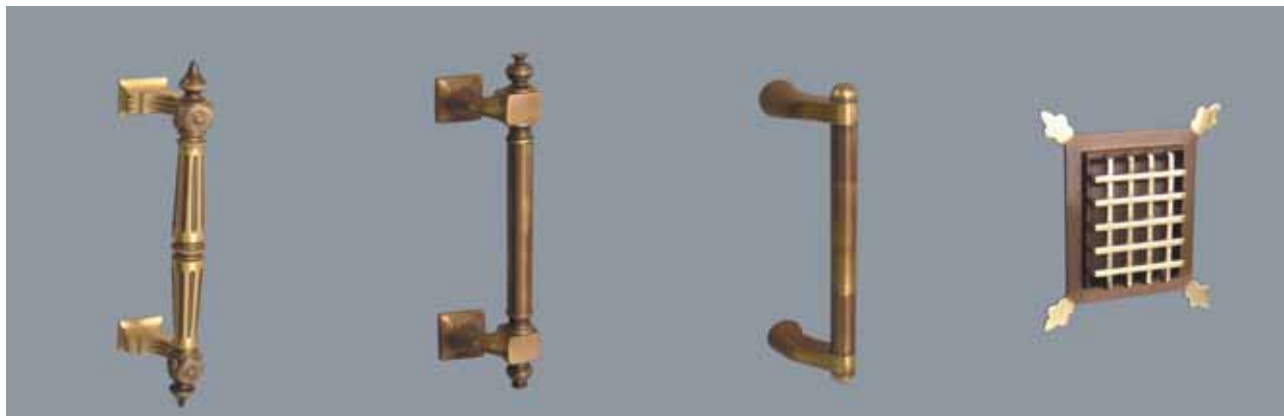

VICTORIA	MONACO	MAYA	MANO
Bb-100	Bb-120	Bb-130	Bb-800



BILORA	ANTILIA
Be-210	Be0034



MISINNA	RICCIO	LEONE	NAXOS
Bb-300	Bb-310	Bb-320	Bb-420



THETA	XI
Bs5270 1	Be0025
Bs5570 1	
Be5270 2 PKM	
Bs5870 1	
Bs6170 1 PKM	
Be5870 2 PKM	

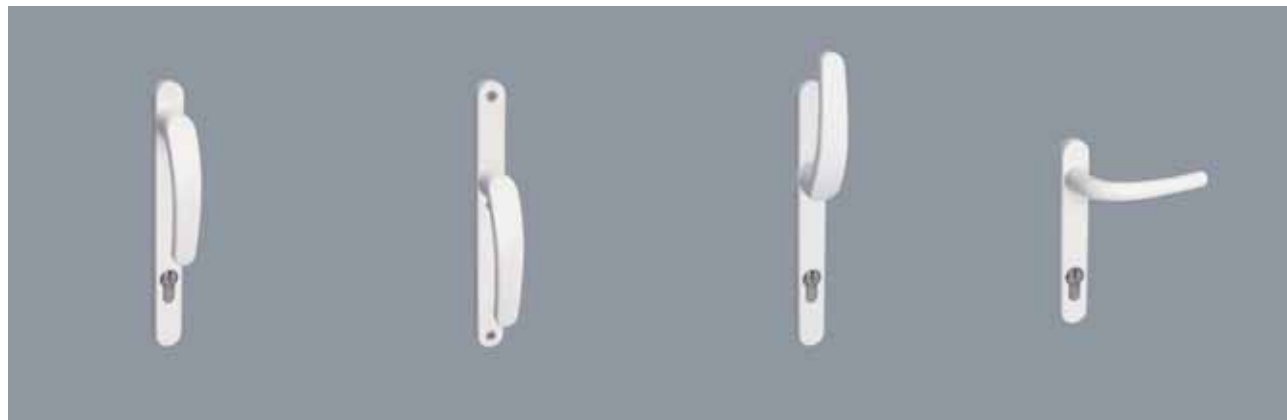

LAMBDA Be1539 5	LAMBDA Bs5339	LAMBDA Bs5039 6	VEGA Be1719 7
Be1639 5		Bs5639 6	Be1819 7
(P600/M5)	(P600)	(P600)	(P600/M5)



MESSING REEKS (B) SERIE LAITON (B)



VEGA



THEMA



START



XENIA



VICTORIA



MONACO



MAYA



NU



MISSINA



RICCIO



LEONE



PSI



NAXOS



XENIA





VEGA





THEMA

profel





TECHNISCHE FICHE REEKS MESSING / GEPOLIJST
FICHE TECHNIQUE SERIE LAITON / POLI

Roepnaam	Artikel	Geschikt voor / geschikt voor:															
					PKM	PVC systeem	PVC systeem	ALU systeem	ALU systeem	HOUT systeem	HOUT systeem	Raam	Deur	Schuifdeur	Balkondeur	Schuif-kip	Schuif-kip
Elisse (PVD)	Bp-140		•			•	•	•				•					
Leone	Bp-320		•			•	•	•				•					
Madrid (PVD)	Bp-330		•			•	•	•				•					
Mano	Bp-800		•			•	•	•				•					
Maya	Bp-130		•			•	•	•				•					
Missina	Bp-300		•			•	•	•				•					
Monaco	Bp-120		•			•	•	•				•					
Naxos	Bp-420		•			•	•	•				•					
Nu	Bp9200	•	•	•		•	•	•				•					
Psi	Bp9300	•	•	•		•	•	•				•					
Regal	Bp-700		•			•	•	•				•					
Riccio	Bp-310		•			•	•	•				•					
Start	Bp5045	•		•		•	•	•				•					
Start	Bp5645		•	•		•	•	•				•					
Taormina	Bp-210		•			•	•	•				•					
Thema	Bp5044	•		•		•	•	•				•					
Thema	Bp5644		•	•		•	•	•				•					
Thema	Bp9444	•				•	•	•			•						
Vega	Bp5019	•		•		•	•	•				•					
Vega	Bp5619		•	•		•	•	•				•					
Vega	Bp9419					•	•	•			•						
Victoria	Bp-100		•			•	•	•				•					
Xenia	Bp5020	•		•		•	•	•				•					
Xenia	Bp5620		•	•		•	•	•				•					
Xenia	Bp9420	•				•	•	•			•						

TECHNISCHE FICHE ALUMINIUM REEKS (GEMOFFELD) A-N
FICHE TECHNIQUE SERIE ALUMINIUM (LAQUE) A-N

Roepnaam Appellation	Artikel Article	Geschikt voor / approprié pour:																							
					PKM	PVC systeem	Système PVC	ALU systeem	Système ALU	HOUT systeem	Système HOUT	Raam	Fenêtre	Deur	Porte	Schuifdeur	Couissant trad.	Balkondeur	Porte-balcon	Schuif-kip	Couissant-tombant	Balkonraam	Fenêtre-balcon	Anodiseerbaar	Anodisable
Antilia	Be0034	•	•			•	•	•					•												•
Bilora	Be-210		•			•	•	•					•												•
Delta 225	Bs5168	•		•		•	•	•					•												
Delta 225	Bs5468	•				•	•	•					•												
Delta 225	Bs5769		•	•		•	•	•					•												
Delta 225	Bs6069		•			•	•	•	•				•												
Delta 300	Be2589	•		•		•	•	•					•												•
Delta 300	Be2689		•	•		•	•	•					•												•
Delta 300	Be2789	•				•	•	•					•												•
Delta 300	Be2889		•			•	•	•					•												•
Epsilon	Be1100	•		•		•	•	•					•			•									•
Epsilon	Be1200		•	•		•	•	•					•			•									•
Epsilon	Be1300	•				•	•	•					•			•									•
Epsilon	Be1400		•			•	•	•					•			•									•
Epsilon	Be3200		•	•		•	•	•					•			•									•
Epsilon	Be3300		•			•	•	•					•			•									•
Iota	Be0024	•	•			•	•	•					•												•
Lambda	Be1539	•		•		•	•	•					•											•	
Lambda	Be1639		•	•		•	•	•					•											•	
Lambda	Be5062	•		•		•	•	•					•			•									
Lambda	Be5662		•	•		•	•	•					•			•									
Lambda	Bn9435	•				•	•	•				•				•									
Lambda	Bn9435*	•				•	•	•				•				•									
Lambda	Bs5039	•		•		•	•	•					•			•									
Lambda	Bs5062	•		•		•	•	•					•			•									
Lambda	Bs5339	•				•	•	•					•			•									
Lambda	Bs5362	•				•	•	•					•			•									
Lambda	Bs5639		•	•		•	•	•					•			•									
Lambda	Bs5662		•	•		•	•	•					•			•									
Lambda	Bs5962		•			•	•	•					•			•									
Lambda	Bs9435	•				•	•	•				•				•									
Lambda	Bs9435*	•				•	•	•				•				•									
Lambda	Bs9536	•				•	•	•				•				•									
Nu	Be9200	•	•	•		•	•	•					•			•									•

TECHNISCHE FICHE ALUMINIUM REEKS (GEMOFFELD) O-Z
FICHE TECHNIQUE SERIE ALUMINIUM (LAQUE) O-Z

Roepnaam Appellation	Artikel Article	Geschikt voor / approprié pour:													
		 Binnenzijde Intérieur	 Buitenzijde Extérieur	 Met cilinder gat Avec trou cylindre	 PKM uitvoering Execution PKM	PVC systeem Système PVC	ALU systeem Système ALU	HOUT systeem Système HOUT	Raam Fenêtre	Deur Porte	Schuifdeur Coulissant trad.	Balkondeur Porte-balcon	Schuif-kip Coulissant-tombant	Balkonraam Fenêtre-balcon	Anodiseerbaar Anodisable
Omega 225	Bs5166	•		•		•	•	•		•					
Omega 225	Bs5466	•				•	•	•		•					
Omega 225	Bs5767		•	•		•	•	•		•					
Omega 225	Bs6067		•		•	•	•	•		•					
Omikron	Be7100	•		•	•	•	•	•		•					•
Omikron	Be7200		•	•	•	•	•	•		•					•
Omikron	Bs7100	•		•		•	•	•		•					
Omikron	Bs7200		•	•		•	•	•		•					
Omikron	Bs7300	•				•	•	•		•					
Omikron	Bs7400		•		•	•	•	•		•					
Pi	Be8075	•		•	•		•				•				
Pi	Be8175		•	•	•		•				•				
Pi	Bs8075	•		•			•				•				
Pi	Bs8175		•	•			•				•				
Pi	Bs8275	•					•				•				
Pi	Bs8375		•		•		•				•				
Rho	Be5064	•		•	•	•	•			•					
Rho	Be5664		•	•	•	•	•			•					
Rho	Bs5064	•		•		•	•	•		•					
Rho	Bs5364	•				•	•	•		•					
Rho	Bs5664		•	•		•	•	•		•					
Rho	Bs5964		•		•	•	•	•		•					
Sigma 300	Be2588	•		•	•	•	•	•		•					•
Sigma 300	Be2688		•	•	•	•	•	•		•					•
Sigma 300	Be2788	•		•		•	•	•		•					•
Sigma 300	Be2888		•		•	•	•	•		•					•
Tau	Be5080	•		•	•	•	•	•		•					
Tau	Be5680		•	•	•	•	•	•		•					
Tau	Bs5080	•		•		•	•	•		•					
Tau	Bs5380	•				•	•	•		•					
Tau	Bs5680		•	•		•	•	•		•					
Tau	Bs5980		•		•	•	•	•		•					
Vega	Be1719	•		•		•	•				•				
Vega	Be1819		•	•		•	•				•				
Zeta	Be5277	•		•	•	•	•	•		•					•
Zeta	Be5877		•	•	•	•	•	•		•					•
Zeta	Bs5277	•		•		•	•	•		•					
Zeta	Bs5577	•				•	•	•		•					
Zeta	Bs5877		•	•		•	•	•		•					
Zeta	Bs6177		•		•	•	•	•		•					



MANO

REGAL

NU

PSI

Bp-800

Bp-700

Bp9200



Bp9300



TAORMINA

NAXOS

Bp-210

Bp-420



VEGA

THEMA

XENIA

Bp9419

Bp9444

Bp9420



VEGA Bp5019
THEMA Bp5044
START Bp5045
XENIA Bp5020
 Bp5619 Bp5644 Bp5645 Bp5620



VICTORIA **MONACO** **MAYA** **ELISSE**
 Bp-100 Bp-120 Bp-130 Bp-140
 (PVD coating)



MISINNA **RICCIO** **LEONE** **MADRID**
 Bp-300 Bp-310 Bp-320 Bp-330
 (PVD coating)

ALU REEKS GEANODISEERD SERIE ALU ANODISE



LAMBDA



RHO



DELTA 300



SIGMA 300



OMNI



BILORA



ZETA



NU



IOTA

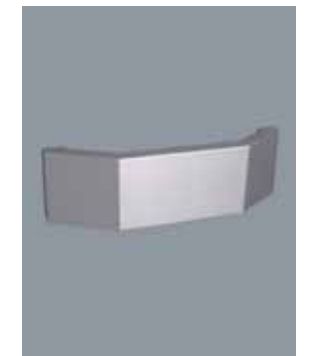

ANTILIA



PERLA



PERLA

profel



LAMBDA		RHO		OMNI		ZETA
Be5062 1				Be2076 2	PKM	Be5277 2
Be5062 2	PKM			Be2276 2		Be5577 2
Be5662 1		Be5664 1		Be2176 2	PKM	Be5877 2
Be5662 2	PKM	Be5664 2	PKM	Be2376 2	PKM	Be6177 2

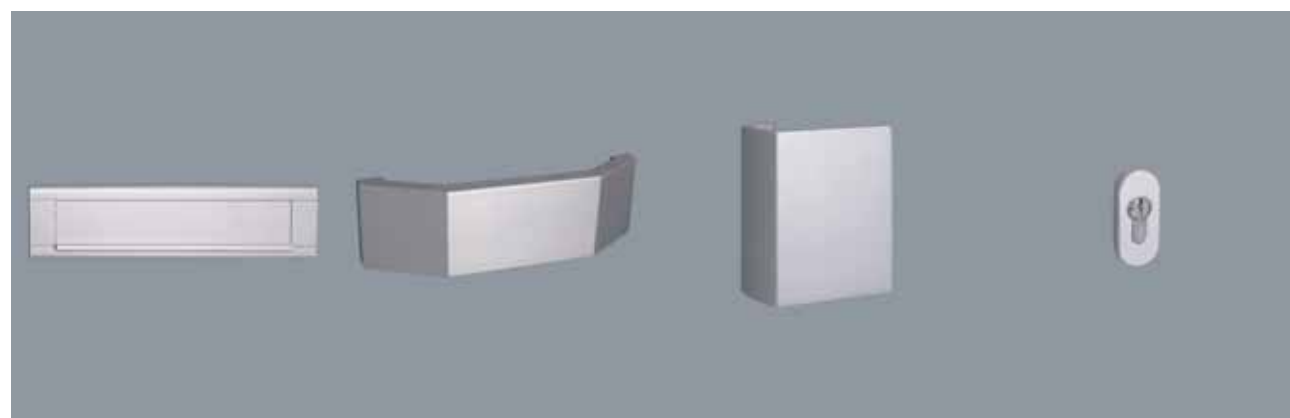

BILORA	ANTILIA	IOTA	NU
Be-210	Be0034	Be0024	Be9200



SIGMA 300	DELTA 300	PERLA	PERLA
Be2588 2	Be2589 2	Be9437	Bs9538
Be2788 2	Be2789 2		
Be2688 2	Be2689 2	Be2889	PKM
Be2888 2	PKM	Be2889 2	PKM

MESSING REEKS (P) SERIE LAITON (P)



VEGA THEMA START XENIA

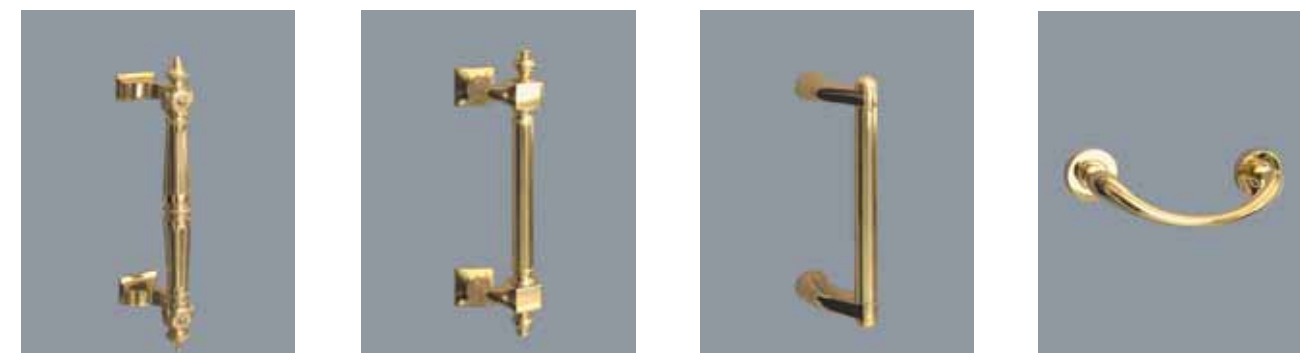

VICTORIA MONACO MAYA ELISSE



MISSINA RICCIO LEONE MADRID



NAXOS XENIA VEGA THEMA

profel

NYLON REEKS SERIE NYLON



LAMBDA
Bn9435

LAMBDA

Bn9435 wit / blanc
Bn9435* (*=afneembare kruk)
(*=poignée demontable)



LAMBDA

LAMBDA

Bn9435 creme / creme
Bn9435* (*=afneembare kruk)
(*=poignée demontable)



LAMBDA

LAMBDA

Bn9435 bruin / brun
Bn9435* (*=afneembare kruk)
(*=poignée demontable)



LAMBDA



LAMBDA
Bn9435* (*=afneembare kruk)
(*=poignée demontable)

LAMBDA

Bn9435 klei bruin / brun
Bn9435* (*=afneembare kruk)
(*=poignée demontable)



LAMBDA

profel

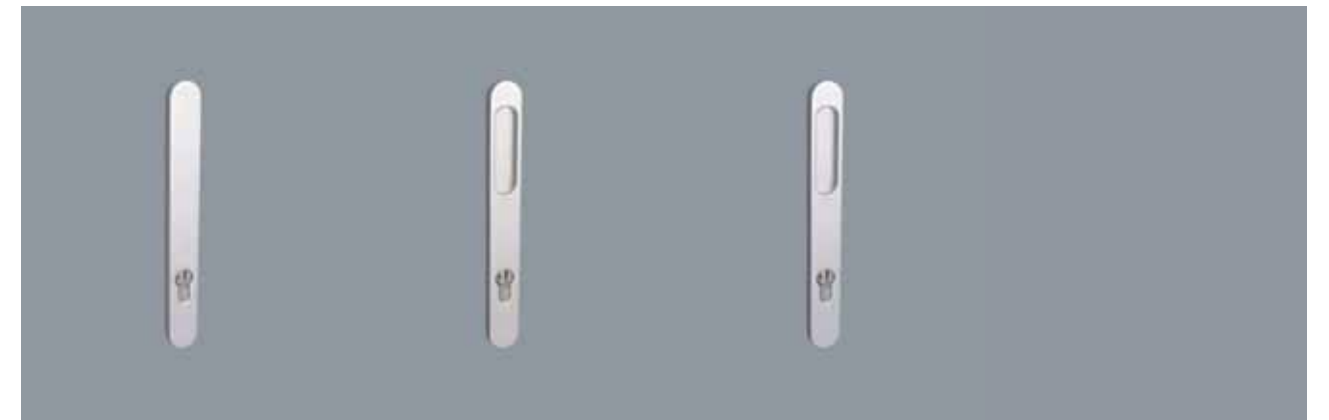

OMIKRON

Be7100 >2
Be7300 >2

EPSILON

Be1100 >2
Be1300 >2

EPSILON

PKM

Be7200 >2
Be7400 >2

PKM



Be1200 >2
Be1400 >2

PKM



Be3200 >1
Be3300 >1
(inbouw/M5)
(encastré/M5)







TECHNISCHE FICHE ALUMINIUM REEKS (GEANODISEERD)
FICHE TECHNIQUE SERIE ALUMINIUM (ANODISE)

Roepnaam Appellation	Artikel Article	Geschikt voor / approprié pour:													
					PKM	PVC systeem Système PVC	ALU systeem Système ALU	HOUT systeem Système HOUT	Raam Fenêtre	Deur Porte	Schuifdeur Couissant trad.	Balkondeur Porte-balcon	Schuif-kip Couissant-tombant		
Antilia	Be0034	•	•			•	•	•		•					
Bilora	Be-210		•			•	•	•		•					
Delta 300	Be2589	•		•	•	•	•	•		•					
Delta 300	Be2689		•	•	•	•	•	•		•					
Delta 300	Be2789	•				•	•	•		•					
Delta 300	Be2889		•		•	•	•	•		•					
Epsilon	Be1100	•		•	•		•				•				
Epsilon	Be1200		•	•	•		•				•				
Epsilon	Be1300	•					•				•				
Epsilon	Be1400		•		•		•				•				
Epsilon	Be3200		•	•			•				•				
Epsilon	Be3300		•				•				•				
Iota	Be0024	•	•			•	•	•		•					
Lambda	Be5062	•		•	•	•	•	•		•					
Lambda	Be5662		•	•	•	•	•	•		•					
Lambda	Bs5062	•		•		•	•	•		•					
Lambda	Bs5662		•	•		•	•	•		•					
Nu	Be9200	•	•	•		•	•	•		•					
Omikron	Be7100	•		•	•	•	•	•		•					
Omikron	Be7200		•	•	•	•	•	•		•					
Omikron	Be7300	•				•	•	•		•					
Omikron	Be7400		•		•	•	•	•		•					
Omni	Be2076	•		•	•		•				•				
Omni	Be2176		•	•	•		•				•				
Omni	Be2276	•					•				•				
Omni	Be2376		•		•		•				•				
Perla	Bs9437	•				•	•	•	•	•					
Perla	Bs9538	•			•	•	•	•	•	•					
Rho	Be5664		•	•	•	•	•	•		•					
Rho	Bs5664		•	•		•	•	•		•					
Sigma 300	Be2588	•		•	•	•	•	•		•					
Sigma 300	Be2688		•	•	•	•	•	•		•					
Sigma 300	Be2788	•				•	•	•		•					
Sigma 300	Be2888		•		•	•	•	•		•					
Zeta	Be5277	•		•	•	•	•	•		•					
Zeta	Be5577	•				•	•	•		•					
Zeta	Be5877		•	•	•	•	•	•		•					
Zeta	Be6177		•		•	•	•	•		•					

TECHNISCHE FICHE REEKS RVS P-Z
FICHE TECHNIQUE SERIE INOX P-Z

Roepnaam Appellation	Artikel Article	Geschikt voor / approprié pour:													
					PKM	PVC systeem Système PVC	ALU systeem Système ALU	HOUT systeem Système HOUT	Raam Fenêtre	Deur Porte	Schuifdeur Couissant trad.	Balkondeur Porte-balcon	Schuif-kip Couissant-tombant		
Perla	Br9538	•			•	•	•	•	•						
Sigma 225	Br5142	•		•		•	•	•		•					
Sigma 225	Br5743		•	•		•	•	•		•					
Sigma 300	Br0086	•				•	•	•		•					
Sigma 300	Br0088		•			•	•	•		•					
Sigma 600	Br0015	•				•	•	•		•					
Sigma 600	Br0016		•			•	•	•		•					
Vega	Bm5019	•		•	•	•	•	•		•					
Vega	Bm5619		•	•	•	•	•	•		•					
Vega	Br5019	•		•		•	•	•		•					
Vega	Br5319	•				•	•	•		•					
Vega	Br5619		•	•		•	•	•		•					
Vega	Br5919		•		•	•	•	•		•					
Vega	Br9419	•				•	•	•	•	•					

TECHNISCHE FICHE REEKS RVS A-O
FICHE TECHNIQUE SERIE INOX A-O

Roepnaam Appellation	Artikel Article	Geschikt voor / approprié pour:												
		 Binnenzijde Intérieur	 Buitenzijde Extérieur	 Met cilindergat Avec trou cylindre	 PKM uitvoering Execution PKM	PVC systeem Système PVC	ALU systeem Système ALU	HOUT systeem Système HOUT	Raam Fenêtre	Deur Porte	Schuifdeur Couissant trad.	Balkondeur Porte-balcon	Schuif-kip Couissant-tombant	
Alfa	Br0012		•			•	•	•						
Alfa	Br0011	•				•	•	•						
Astra	Bm5040	•		•	•	•	•	•						
Astra	Bm5640		•	•	•	•	•	•						
Astra	Br 9441	•				•	•	•	•					
Astra	Br5040	•		•		•	•	•						
Astra	Br5340	•				•	•	•						
Astra	Br5640		•	•		•	•	•						
Astra	Br5940		•		•	•	•	•						
Beta 300	Br0095	•				•	•	•						
Beta 300	Br0096		•			•	•	•						
Delta 225	Br5168	•		•		•	•	•						
Delta 225	Br5769		•	•		•	•	•						
Delta 300	Br0087	•				•	•	•						
Delta 300	Br0089		•			•	•	•						
Idra	Br-210		•			•	•	•						
Kappa	Br0013	•				•	•	•						
Kappa	Br0014		•			•	•	•						
Nu	Bm9200		•	•		•	•	•						
Nu	Br9200	•		•		•	•	•						
Omega 225	Br5166	•		•		•	•	•						
Omega 225	Br5767		•	•		•	•	•						
Omega 300	Br0090	•				•	•	•						
Omega 300	Br0091		•			•	•	•						
Omikron	Br7100	•		•		•	•	•						
Omikron	Br7200		•	•		•	•	•						
Omikron	Br7300	•				•	•	•						
Omikron	Br7400		•		•	•	•	•						
Omni	Br2076	•		•		•	•	•						
Omni	Br2176		•	•		•	•	•						
Omni	Br2276	•				•	•	•						
Omni	Br2376		•		•	•	•	•						
Onda	Bm5063	•		•	•	•	•	•						
Onda	Bm5663		•	•	•	•	•	•						
Onda	Br5063	•		•		•	•	•						
Onda	Br5363	•				•	•	•						
Onda	Br5663		•	•		•	•	•						
Onda	Br5963		•		•	•	•	•						

RVS REEKS SERIE INOX



VEGA



ASTRA



ONDA



ALFA



SIGMA 225



DELTA 225



OMEGA 225



KAPPA



SIGMA 300



DELTA 300



OMEGA 300



BETA



VEGA



ASTRA



PERLA



OMNI

profel



VEGA		ASTRA		ONDA		OMNI	
Br5019	1	Br5040	1	Br5063	1	Br2076	1
Br5319	1	Br5340	1	Br5363	1	Br2276	1
Bm5019	2	Bm5040	2	Bm5063	2		
Br5619	1	Br5640	1	Br5663	1	Br2176	1
Br5919	1	Br5940	1	Br5963	1	Br2376	1
Bm5619	2	Bm5640	2	Bm5663	2		



OMIKRON		NU		NU		IDRA	
Br7100	1	Br9200					
Br7300	1						
Br7200	1			Bm9200		Br-210	
Br7400	1	PKM					

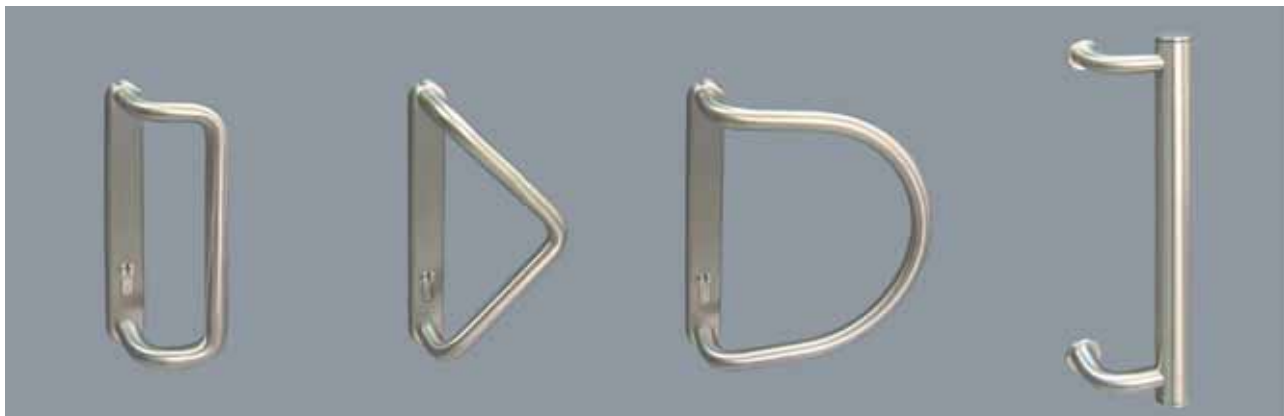

SIGMA 225		DELTA 225		OMEGA 225		KAPPA	
Br5142	3	Br5168	3	Br5166	3	Br0013	1
Br5743	1/3	Br5769	1/3	Br5767	1/3	Br0014	1



ALFA		BETA 600	
Br0011	1	Br0017	4
Br0012	1	Br0018	1/4



SIGMA 300		DELTA 300		OMEGA 300		BETA 300	
Br0086	4	Br0087	4	Br0090	4	Br0095	4
Br0088	1/4	Br0089	1/4	Br0091	1/4	Br0096	1/4



SIGMA 600		VEGA		ASTRA		PERLA	
Br0015	1	Br9419		Br9441		Br9538	
Br0016	1						